

15. WARRANTY

Royal Sovereign International warrants the equipment sold is free from defects in material and workmanship for a period of One (1) year for Parts and Labor from the date of installation, excluding lamination rollers which are warranted for Six (6) months. This warranty is extended only to the original purchaser. This warranty is the only warranty made by Royal Sovereign International and cannot be modified or amended. Royal Sovereign's sole and exclusive liability and the customer's sole and exclusive remedy under this warranty shall be, at Royal Sovereign's option, to repair or replace any such defective part or product. These remedies are only available if Royal Sovereign's examination of the product discloses to Royal Sovereign's satisfaction that such defects actually exist and were not caused by misuse, neglect, attempt to repair, unauthorized alternation or modification, incorrect line voltage, fire, accident, flood or other hazard.

All warranty claims must be filed through the authorized Royal Sovereign dealer or reseller through which the equipment was originally purchased. Model, serial number and date of delivery are required for all claims.

The warranty made herein is in lieu of all other warranties, expressed or implied, including any warranty or merchantability or fitness for a particular purpose. Royal Sovereign will not be liable for personal damage or personal injury (unless primarily caused by its negligence), loss of profit, or other incidental or consequential damages arising out of the use or inability to use this equipment.

LIMITED WARRANTY

This warranty specifically does not cover damage to laminating rollers caused by knives, razor blades, or any sharp objects or abrasives, or failure caused by adhesives, or damage caused by lifting, tilting or improper use of the machine. Warranty repair or replacement by Royal Sovereign or its authorized Reseller(s) does not extend the warranty beyond the initial one year period from the date of installation. Unauthorized customer alterations will void this warranty.

CORPORATE HEADQUARTERS

Royal Sovereign International Inc.

2 Volvo Drive, Rockleigh, NJ 07647 U.S.A.

TEL : +1) 800-397-1025 FAX : +1) 201-750-1022

E-mail : info@royalsovereign.com

RS Holland B.V.

Planetenweg 75 2132HM Hoofddorp, The Netherlands.

TEL : +31) 23-5626620, +31) 23-5654451

FAX : +31) 23-5654565

E-mail : purchaseorder@royalsovereign.com

Royal Sovereign Inc. <Oversea Sales Office>

1001, World Meridian II, 426-5, Gasan-dong,

Geumcheon-gu, Seoul, 153-759, KOREA

TEL : +82)2-2025-8800 FAX : +82)2-2025-8830

E-mail : sales@royalsovereign.com

RS Canada Inc.

164 Oakdale Road, Toronto, Ontario M3N 2S5

CANADA

TEL : +1) 416-741-8400 FAX : +1) 416-741-8185

E-mail : info@royalsovereign.com

RS International Australia PTY. LTD.

30 Prime Drive, Seven Hills, NSW 2147, Australia

TEL : +61) 2-9674-2127

FAX : +61) 2-9674-2027

E-mail : salesaust@royalsovereign.com

OWNER'S MANUAL

RSL-2702 Laminator



Read all instructions carefully before use.

For any Customer Support needs please choose the
Customer Support tab on www.royalsovereign.com

Royal Sovereign International Inc.
www.royalsovereign.com

TABLE OF CONTENTS

TOPIC	PAGE
1. Introduction.....	2
2. Safety Precautions	2
3. Included with Laminator	3
4. Product Identification.....	3
5. Loading Film.....	4
6. Threading Film	
6.1. Hot Film.....	5-6
6.2. Cold Film	7
6.3. Mounting.....	8
7. Control of Roller Pressure	9
8. Control Panel.....	10
9. Laminating Steps	
9.1. Hot Laminating.....	11-12
9.2. Cold Laminating	13
10. Using Cross Cutter.....	14
11. Maintenance.....	15
12. Troubleshooting	16
13. Recommended Temperature and Speed Settings.....	17
14. Specifications	18
15. Warranty.....	19

1. INTRODUCTION

Thank you for choosing a Royal Sovereign laminator. It has been designed and manufactured to provide years of continuous service. For complete operating and maintenance information please read this manual thoroughly. Upon receipt of your laminator, please inspect the box, the machine and all other contents for shipping damage. Damage should be brought to the immediate attention of the delivering carrier (See page 3 for list of shipment elements).

2. SAFETY PRECAUTIONS

Failure to comply with any of the following safety procedures could result in serious injury. Please read the instructions carefully and keep for future reference.

1. Only a licensed electrician should install wiring and outlet for the laminator.
2. Ensure the unit is plugged into a properly grounded outlet with the correct voltage.
3. Keep hands and clothing (i.e. Neckties) away from rollers. The rollers have pinch points that can trap body parts or clothing and cause serious injury.
4. Keep flammable and wet objects away from the machine.
5. Place machine on a level surface.
6. Avoid excessive sunlight, humidity and extreme temperatures.
7. Ensure the unit is turned off, cooled, and unplugged from the outlet prior to moving and/or repairing.
8. Keep out of reach of children.
9. Only Royal Sovereign authorized maintenance and service technicians should make repairs.
10. Do not attempt to laminate items that exceed total recommended material thickness for the unit
11. When cleaning the machine, don't use flammable sprays or materials.
12. Do not touch the rollers when they are hot or place foreign objects inside the machine.
13. Do not cover the surface of the machine until the machine has completely cooled.

3. INCLUDED WITH LAMINATOR

PART NAME	EA	REMARK	PART NAME	EA	REMARK
FUSE(65TS) (AC250V 10A)	1	Power supply: 220V~240V	FUSE(65TS) (AC250V 20A)	1	Power supply: 100V~120V

4. PRODUCT IDENTIFICATION

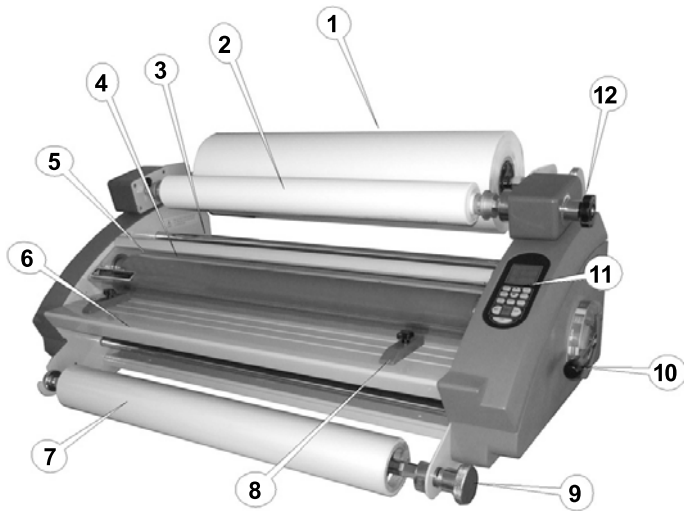

NO	PART NAME	NO	PART NAME
1	UPPER FILM	7	LOWER FILM
2	TAKE-UP BOBBIN	8	GUIDE-DOCUMENT
3	IDLE BAR	9	HANDLE-TENSION
4	HOT ROLLER	10	PRESSURE LEVER
5	SAFETY COVER	11	CONTROL PANEL
6	FRONT-TABLE	12	KNOB-TENSION

5. LOADING FILM

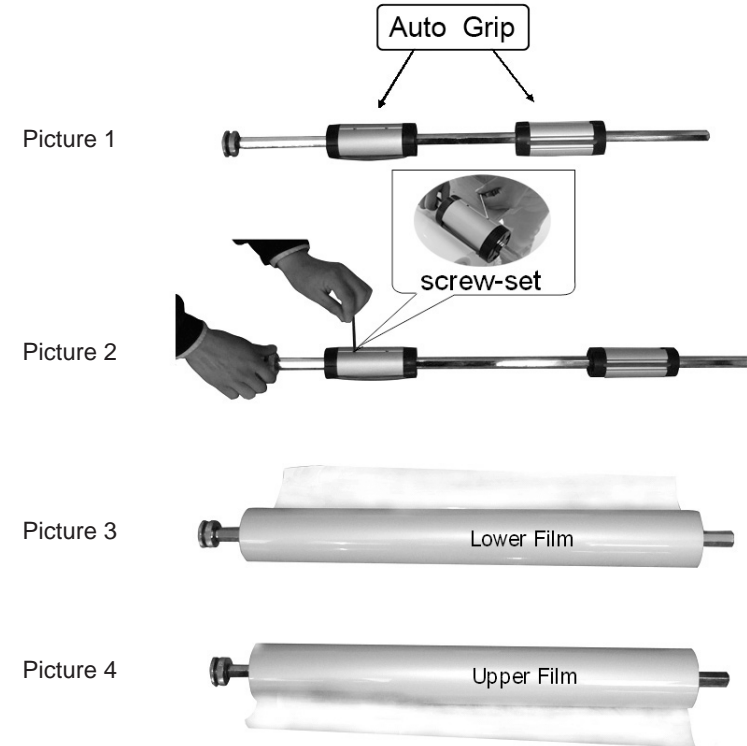

- As shown in picture 1, insert auto grips onto the upper/lower film shaft.
- As shown in picture 2, using the special tool, fix the auto grips on the film shaft with set-screws.
- Set the glossy side of the upper and lower film towards the heat rollers. (Glossy side is PET film and matte side is thermal polymer laminating adhesive)
- Center film as shown in picture 3 and 4.

6. THREADING FILM

6.1. HOT FILM

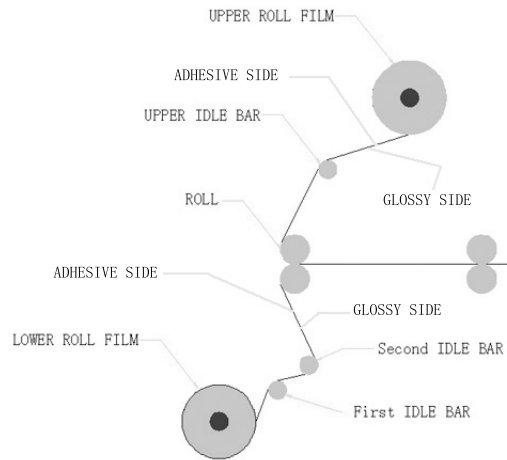

1. Turn the power switch on("I" position). Power switch is located in the rear of the unit on the left side.
2. Complete the "Loading Film" steps as shown on page 4.
3. Set the temperature and speed according to the Recommended Temperature and Speed section.
4. Remove the Front Table.
5. Pull down the upper film over the Safety Cover to the lower film; align and center the lower film to upper film (Picture 1).
6. Rewind the upper film until the film aligns with the Safety Cover.
7. Thread the film over the Upper Idle Bar and underneath the Safety Cover until the film rests on the upper roller (Picture 2).

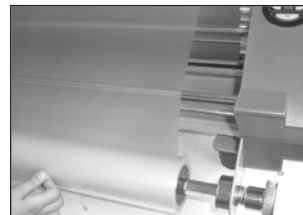

Picture 1



Picture 2

8. Carefully pull up the laminate from the lower roll up towards the first idle bar and then around the back side of the second Idler (Caution: lower roller may be hot).(Picture 3)
9. Tack the lower film to the upper film that is resting on the main roller (Picture 4).
10. Reinstall the Front Table and close the Safety Cover.
11. Adjust the nip setting to 1/4" (6mm).
12. Insert and push the leader boards on each end until boards reach the front nip point.
13. Adjust the nip setting to "Laminating" mode.
14. Push the Run button.
15. Push the leader boards between the pair of main rollers (Picture 5).
16. Press the Run button and adjust the supply roll tension knobs by rotating clockwise or counterclockwise. Turn it until the supply roll films have some resistance (the tension varies depending on the film thickness; the thicker the film the more tension is required) (Picture 6).
17. Press Stop button when the leader board has completely exited the rear of the unit.
18. Use the Cross Cutter to cut the leader board from the web (see page 18).
19. Peel Trim any excess film off of the leader board edges. The leader board can be reused.
20. Set the roller nip setting to the appropriate position for the lamination or encapsulation application.

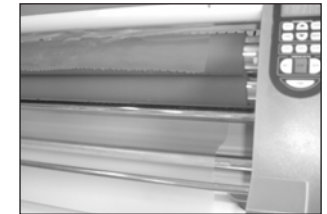

Picture 3

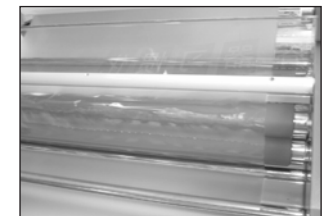

Picture 4



Picture 5



Picture 6

6.2. COLD FILM

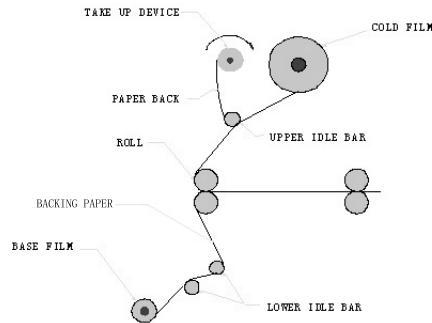

1. Follow the steps in the "Loading Film" procedure by loading the upper shaft with pressure sensitive film, e.g. (Royal Print-Pro Film) and lower shaft with pressure sensitive mounting adhesive films or backing paper (Royal Sovereign White-Mount or Clear-Mount).
2. Pull the upper laminate under the upper idle bar and separate the release liner from the laminate.
3. Tape the release liner to the Take-Up Paper Core and allow the laminate to hang over the main rollers.
4. Pull up the mounting adhesive and tack it to the laminate hanging over the rollers (do not use the Lower Idle Bar).
5. Reinstall the Front Table, and close the Safety Cover.
6. Adjust the nip setting to 1/4"(6mm).
7. Insert and push the leader board until board reaches the nip point.
8. Press the Run button and adjust the supply roll tension knobs by rotating clockwise or counterclockwise. Turn it until the supply roll films have some resistance (the tension varies depending on the thickness of a film; the thicker the film the more tension is required).
9. Press Stop button when the leader board has completely exited the rear of the unit.
11. Use the Cross Cutter to cut the leader board from the web (see page18).
12. Set the roller nip setting to the appropriate position for the lamination application.

6.3. MOUNTING

1. Lay the decal image face down on a flat surface. Carefully peel back and put a crease along the edge of the release liner (Approximately 1 inch or 25mm, Figure 1).
2. With the image facing up, align the image onto the board. Press firmly from the center out (Figure 2).
3. Adjust the pressure lever to ensure the proper opening (Figure 3).
4. Flip the image over the upper roller and hold on to the release liner (Figure 4).
5. Press the foot pedal once, and then let it go while slowly pulling the release liner as the board enters the main roller nip (Figure 5).

Press the foot pedal once again when the board has completely exited from the rear of the unit. Trim the board if necessary.



Figure 1



Figure 2



Figure 3

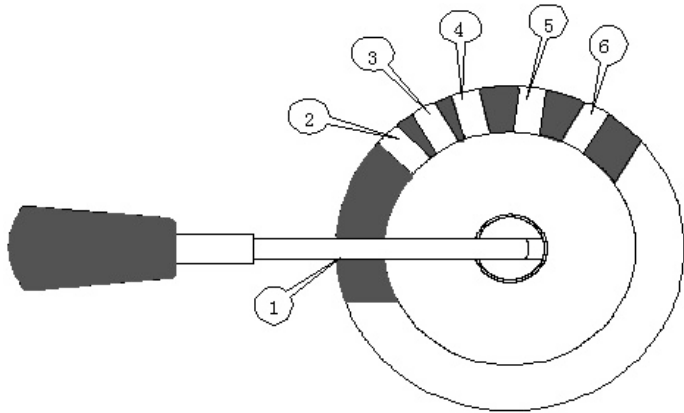

Figure 4



Figure 5

7. CONTROL OF ROLLER PRESSURE



To set, pull the pressure lever outward and turn to one of the following positions.

- ① OPEN: For detaching and cleaning rollers.
- ② 6MM: For laminating 6mm[0.24in] thick board.
- ③ 5MM: For laminating 5mm[0.2in] thick board.
- ④ 3MM: For laminating 3mm[0.12in] thick board.
- ⑤ 1.5MM: For laminating 1.5mm[0.06in] thick board.
- ⑥ LAMINATING: For laminating 25~250micron(1~10mil) thick film and cold film.

8. CONTROL PANEL

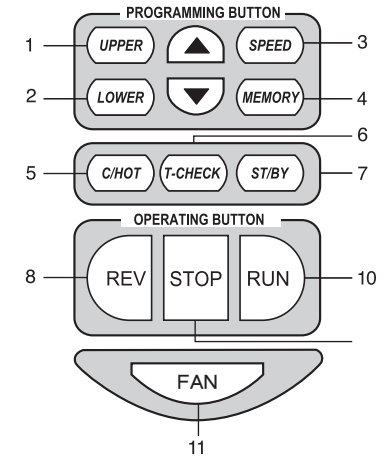

1. **UPPER:** To change upper roller temperature by pressing button, then up or down arrow. (range 32~302°F or 0~150°C)
2. **LOWER:** To change lower roller temperature by pressing button, then up or down arrow. (range 32~302°F or 0~150°C)
3. **SPEED:** To change speed of the rollers by pressing button, then up or down arrow. (range 1 through 9)
4. **MEMORY:** To recall or change presets. To recall the settings, press MEMORY then up or down arrow. To save the settings, set desired temperatures and speeds then press the MEMORY button twice. (stores up to 9 different settings)



5. **C/HOT:** To change the mode from hot to cold or cold to hot lamination. In cold mode, the speed defaults to 2 (speed 1~4 settings) and stand-by function is disabled.
 6. **T-CHECK:** To check current upper and lower roller temperatures. Display automatically returns to the previous settings after 5 blinks.
 7. **ST/BY:** To change to stand-by mode (temperature will automatically reset to 176°F (80°C). While in this mode, all the buttons on the control panel are disabled. Press ST/BY mode button to resume normal operation.
- NOTE: Auto stand by mode and auto power off mode**
-Stand by mode: If no activity is made within 2 hours after each use the machine will automatically switch into stand by mode.
-Auto power off mode: If the machine is in stand by mode and no activity is made for 60 minutes the machine will automatically power off.
-If any activity is made while in stand by or auto power off mode the machine will return to it's previous stage.
8. **REV:** To reverse the rollers. Must press and hold the button to activate.
 9. **STOP:** To stop the rollers from turning.
 10. **RUN:** To start the rollers .
 11. **FAN:** To activate the cooling fans.

9. LAMINATING STEPS

9.1. HOT LAMINATING

1. Turn on the power switch located on the rear of the machine.
2. Set the pressure lever to the "Laminating mode".
3. Increase the roller temperature. If you already have a setting in the memory that you want to use press the **MEMORY** button and then the  or  buttons to select your desired setting.
4. When the desired temperature is met "READY" will be displayed on the screen and you will hear a beep.
5. Press the **RUN** button. The rollers should begin to turn, if they do not turn make sure the safety cover is closed or check the troubleshooting section of the manual.
6. Use the upper and lower Tension knobs to properly adjust the tension of the roll film. Having the tension too tight will slow down or prevent the rollers from turning and if the tension is set too low this can cause wrinkles in your lamination.
7. For ease and convenience set the document guides in position.
8. Set document on the table. You should allow at least 5mm(1/4") space on each side for perfect lamination.
9. Press the **STOP** button when lamination is completed.
10. When lamination is completed your item may be hot and can easily bend. Lay on a flat surface to properly cool.
11. When you have completed all of your lamination, set the pressure lever to the OPEN position.
12. Turn the Power switch off.



— Useful Information —

1. You can preset up to 9 temperature and speed settings in the memory for faster easier use.
2. When laminating continuously "WAIT" may appear on the display, if this occurs lower the speed by 1 increment, "READY" should appear and you may continue laminating.
3. When laminating a document much smaller than the film, place the document in the center of the film for better lamination results.
4. When laminating at high temperatures (> 248°F/120°C) you may want to press the FAN button to allow the cooling fan to cool the document being laminated.

— Laminating Speed at each level(mm/min) —

SPEED	HOT / COLD MODE
1	300
2	500
3	700
4	900
5	1100
6	1500
7	1800
8	2100
9	2500

9.2. COLD LAMINATING

- Put cold roll film on upper shaft. Load backing paper on the lower shaft as per illustration 6.2 on page 7.
- Pull COLD film and fix it so that the Release Liner can be wound on take-up mandrel clockwise. (Revolve core to make Release Liner a little tight)
- Set pressure lever to the proper position according to your laminating condition.
- After pressing the **C/HOT** button, choose and set proper speed by using the **SPEED** and   button.
- It is **READY** when ready is displayed on the screen and beeps three times.
- Turn on the take up device and set the proper film tension by pressing the "RUN" button. Lower tension would make better operation.
- Center the document on the table. For ease and convenience set the document guides in position
- Press the "RUN" button and "take up motor" at the same time. The liner and film will roll at the same time.
- When lamination is completed, press the **STOP** button.
- Set pressure lever at the "OPEN" mode.
- Turn off the power switch.

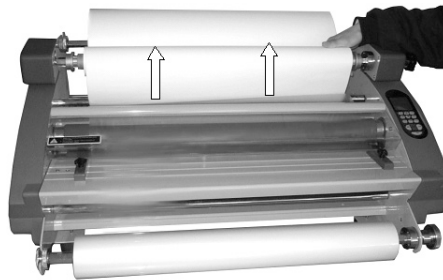

10. USING CROSS CUTTER

The cross cutter is located on the rear exit table of the machine.

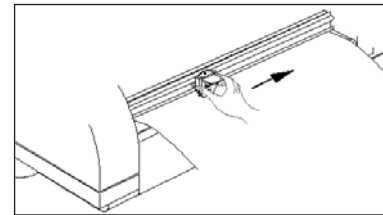

Figure 1

- After lamination, move the cutter approximately to the center of the completed application at the desired point of detachment (Figure 1).

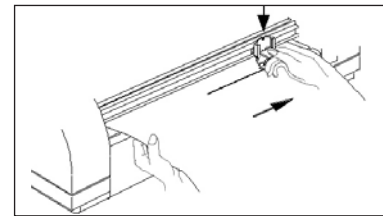

Figure 2

- Grasp film with one hand, press the cutter downward into the application and slide it first to one end of the application, then to the other end to complete the cut. (Figure 2 & 3)

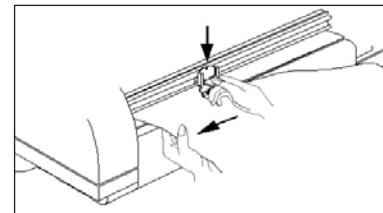

Figure 3

11. MAINTENANCE

Cleaning the Body of the laminator

To clean the machine body, dampen a cloth with water only and gently wipe the machine clean.

Removing Adhesive Build Up

1. Remove the film from the laminator.
2. Use a damp (water only) cloth and a rubber gum eraser to remove the adhesive on the Teflon (metal) and silicone rollers.

NOTE: Rub firmly but do not scrub the rollers vigorously as this may scratch the surface. Do not use sharp metal objects, steel wool, or abrasive, as these may also damage the rollers.

12. TROUBLESHOOTING

Symptom	Cause	Possible Solution
Machine will not turn on:	<ol style="list-style-type: none"> a. Power switch is in "0" (Off) position b. Tripped circuit breaker. c. Blown main power fuse. 	<ol style="list-style-type: none"> a. Put the power switch to the "I" (On) position b. Reset the circuit breaker. c. Replace the fuse.
There is power, but the rollers are not turning after the "RUN" button is pressed:	<ol style="list-style-type: none"> a. Safety cover is not closed. b. Paper guide is not installed correctly. c. Blown motor fuse. 	<ol style="list-style-type: none"> a. Close the safety cover to activate the safety switch. b. Properly install the paper guide so that the micro switch is activated. c. Replace the motor fuse.
The unit is not heating up	<ol style="list-style-type: none"> a. The machine is in "COLD" mode. b. Set temperature is lower than the room temperature. 	<ol style="list-style-type: none"> a. Switch to "HOT" mode. b. Raise the temperature according to the recommended film temperature.
Curled lamination:	<ol style="list-style-type: none"> a. Upward curl. b. Downward curl. 	<ol style="list-style-type: none"> a. Loosen the top roll film tension. b. Loosen the bottom roll film tension.
Unclear lamination:	The main roller temperatures are too low and/or lamination speed is too fast.	Raise the roller temperatures and/or lower the lamination speed.

13. Recommended Temperature and Speed Settings.

NO	Film thickness	Preset			User		Remark
		Temp	Speed	Func'No	Temp	Speed	
1	38 micron (1.5 mil)	100°C (212°F)	5	1			
2	75 micron (3 mil)	105°C (221°F)	4	2			
3	80 micron (3.2 mil)	105°C (221°F)	5	3			
4	100 micron (4 mil)	110°C (230°F)	4	4			
5	125 micron (5 mil)	120°C (248°F)	5	5			
6	150 micron (6 mil)	125°C (257°F)	3	6			
7	175 micron (7 mil)	130°C (266°F)	4	7			
8	200 micron (8 mil)	135°C (275°F)	3	8			
9	250 micron (10 mil)	140°C (284°F)	3	9			

NOTE: Speed and temperature should be adjusted in accordance with film manufacturer's recommendations.

14. SPECIFICATIONS

Description	RSL-2702
Power supply	AC 100, 200, 220~240V 50/60Hz 120V 60Hz
Power consumption	1500W
Max. laminating width	685mm / 27"
Film thickness	25~250 mic / 1~10mil
Max. laminating speed	2.5m/min / 8.2ft/min
Ready time	10min
Heating method	Hot roller
Driving motor	DC geared
Max. Temperature control	150°C / 302°F
Speed control	9 settings
Transport type	4 Roller
Film core size	Auto grip (2", 3")
Cooling system	2 AC FAN
Cross cutter	Yes
Hot lamination	Yes
Cold lamination	Yes
Mounting thickness	6mm / 0.24"
Take up system	Chain link to main motor
Reverse	Yes
Unit dimensions (w x d x h)	970 × 540 × 470 (mm) 38" × 21.5" × 18.5"
Unit weight	56kg / 124lbs
Carton dimensions (w x d x h)	1130 × 740 × 600 (mm) 44.5" × 24" × 23.5"
Gross Weight	71kg / 157lbs